

30W, AC-DC converter



CE Report
EN62368-1

CB
IEC62368-1

UK
CA
BS EN 62368-1

RoHS



FEATURES

- Wide 176 - 528VAC and 248 - 746VDC input voltage range
- Working available with any two phases
- Operating ambient temperature range: -40°C to +85°C
- High I/O isolation test voltage up to 4000VAC
- Up to 88% efficiency
- Output short circuit, over-current, over-voltage protection
- EMI performance meets CISPR32 / EN55032 CLASS B

LD30-26BxxR2 series AC-DC converters are highly efficient, environmental-friendly 30W power modules. The feature ultra wide AC input and at the same time accepts DC input voltage, low power consumption, high efficiency, high reliability, reinforced isolation. It offers good EMC performance compliant to IEC/EN61000-4 and CISPR32/EN55032 and meets IEC/EN/UL62368/EN61558 standards. The converters are widely used in industrial, power, instrumentation, communication and charging pile applications. For extremely harsh EMC environment, we recommend using the application circuit show in Design Reference of this datasheet.

Selection Guide

Certification	Part No.	Output Power	Nominal Output Voltage and Current (Vo/Io)	Efficiency at 230VAC (%) Typ.	Capacitive Load (uF) Max.
EN/IEC	LD30-26B03R2	19.8W	3.3V/6000mA	82	15000
	LD30-26B05R2	30W	5V/6000mA	84	15000
	LD30-26B09R2	30.06W	9V/3340mA	85	8200
	LD30-26B12R2	30W	12V/2500mA	85	4700
	LD30-26B15R2	30W	15V/2000mA	85	3300
	LD30-26B24R2	30W	24V/1250mA	86	1500
	LD30-26B48R2	30W	48V/625mA	88	820

Note: The product picture is for reference only. For details, please refer to the actual product.

Input Specifications

Item	Operating Conditions	Min.	Typ.	Max.	Unit
Input Voltage Range	AC input	176	--	528	VAC
	DC input	248	--	746	VDC
Input Frequency		47	--	63	Hz
Input Current	230VAC	--	--	0.5	A
	380VAC	--	--	0.35	
Inrush Current	230VAC	--	35	--	
	380VAC	--	60	--	
Leakage Current	480VAC/50Hz	0.5mA RMS Max.			
Recommended External Input Fuse		3.15A/500V, slow-blow, required			
Hot Plug		Unavailable			

Output Specifications

Item	Operating Conditions	Min.	Typ.	Max.	Unit	
Output Voltage Accuracy	3.3V	--	±3.0	--	%	
	5V/9V/12V/15V/24V/48V	--	±2.0	--		
Line Regulation	Full load	3.3V	--	±1.0		%
		5V/9V/12V/15V/24V/48V	--	±0.5		
Load Regulation	0% -100% load	3.3V	--	±2.0	%	
		5V/9V/12V/15V/24V/48V	--	±1.0		--
Ripple & Noise*	20MHz bandwidth (peak-to-peak value)	--	80	150	mV	

Stand-by Power Consumption	230VAC	--	--	0.3	W
	380VAC	--	--	0.5	
Temperature Coefficient		--	±0.02	--	%/°C
Short Circuit Protection		Hiccup, continuous, self-recover			
Over-current Protection		≥110%Io, self-recover			
Over-voltage Protection	3.3/5VDC output	≤7.5VDC (Clamp or hiccup)			
	9/12VDC output	≤16VDC (Clamp or hiccup)			
	15VDC output	≤25VDC (Clamp or hiccup)			
	24VDC output	≤35VDC (Clamp or hiccup)			
	48VDC output	≤60VDC (Clamp or hiccup)			
Minimum Load		0	--	--	%
Hold-up Time	230VAC input	--	45	--	ms
	380VAC input	--	120	--	
Note: * The "parallel cable" method is used for ripple and noise test, please refer to AC-DC Converter Application Notes for specific information.					

General Specifications

Item	Operating Conditions	Min.	Typ.	Max.	Unit
Isolation	Input-output	Electric Strength Test for 1min., leakage current <5mA			VAC
Operating Temperature		-40	--	+85	°C
Storage Temperature		-40	--	+85	
Storage Humidity		--	--	95	%RH
Soldering Temperature	Wave-soldering	260 ± 5°C; time: 5 - 10s			
	Manual-welding	360 ± 10°C; time: 3 - 5s			
Switching Frequency		--	65	--	kHz
Power Derating	+55°C to +70°C	3	--	--	% / °C
	+70°C to +85°C	1.33	--	--	
Safety Standard		IEC/EN/BS EN 62368-1 safety approval; Design refer to UL62368-1, IEC/EN61558-1			
Safety Class		CLASS II			
MTBF		MIL-HDBK-217F@25°C >950,000 h			

Mechanical Specifications

Case Material	Black plastic, flame-retardant and heat-resistant (UL94V-0)
Dimension	70.00 x 48.00 x 30.00 mm
Weight	152g (Typ.)
Cooling method	Free air convection

Electromagnetic Compatibility (EMC)

Emissions	CE	CISPR32/EN55032	CLASS B	
	RE	CISPR32/EN55032	CLASS B	
Immunity	ESD	IEC/EN61000-4-2	Contact ±6KV / Air ±8KV	perf. Criteria A
	RS	IEC/EN61000-4-3	10V/m	perf. Criteria A
	EFT	IEC/EN61000-4-4	±2KV	perf. Criteria A
		IEC/EN61000-4-4	±4KV (See Fig. 1 for typical application circuit, See Fig. 2, Fig. 3 for recommended circuit)	perf. Criteria A
	Surge	IEC/EN61000-4-5	line to line ±2KV (See Fig.1 for typical application circuit)	perf. Criteria A
IEC/EN61000-4-5		line to line ±4KV (See Fig. 2 for recommended circuit)	perf. Criteria A	

		IEC/EN61000-4-5 line to line $\pm 2\text{KV}$ /line to PE $\pm 4\text{KV}$ (See Fig. 3 for recommended circuit)	perf. Criteria A
	CS	IEC/EN61000-4-6 10Vr.m.s	perf. Criteria A
	Voltage dip, short interruption and voltage variation	IEC/EN61000-4-11 0%, 70%	perf. Criteria B

Product Characteristic Curve

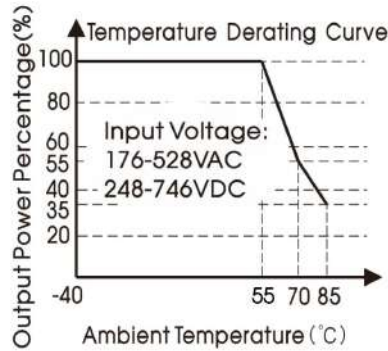

Note: This product is suitable for applications using natural air cooling; for applications in closed environment please consult Mornsun FAE.

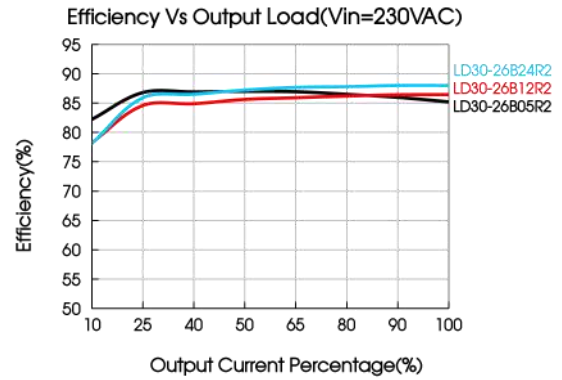
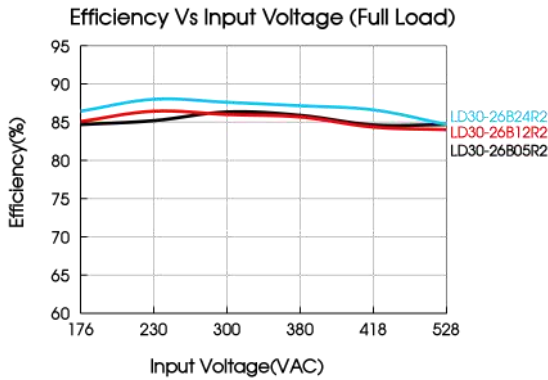

Design Reference

1. Typical application

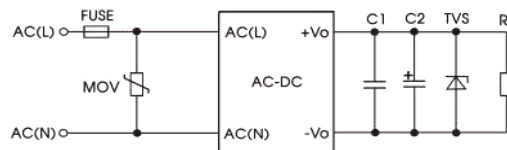

Fig. 1: Typical circuit diagram

Part No.	FUSE	MOV	C1	C2	TVS
LD30-26B03R2	3.15A/500V, slow-blow, required	S14K550	1uF/50V	330uF/25V	SMBJ7.0A
LD30-26B05R2				330uF/25V	SMBJ7.0A
LD30-26B09R2				220uF/25V	SMBJ12A
LD30-26B12R2				220uF/25V	SMBJ20A
LD30-26B15R2				220uF/35V	SMBJ30A
LD30-26B24R2				220uF/35V	SMBJ30A
LD30-26B48R2				10uF/63V	SMBJ64A

Output Filter Components:

We recommend using an electrolytic capacitor with high frequency, and low ESR rating for C2 (refer to manufacture's datasheet). Choose a Capacitor voltage rating with at least 20% margin, in other words not exceeding 80%. C1 is a ceramic capacitor used for filtering high-frequency noise and TVS is a recommended suppressor diode to protect the application in case of a converter failure.

2. EMC compliance recommended circuit

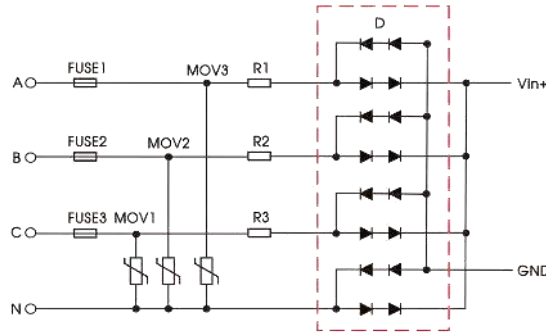

Fig. 2: Line to line ±4kV EMC application circuit with higher requirements

Component	Recommended value
MOV1/MOV2/MOV3	S20K550
D	2A/1000V
R1/R2/R3	12 Ω /5W (wire-wound resistor)
FUSE1/FUSE2/FUSE3	3.15A/500V, slow-blow, required

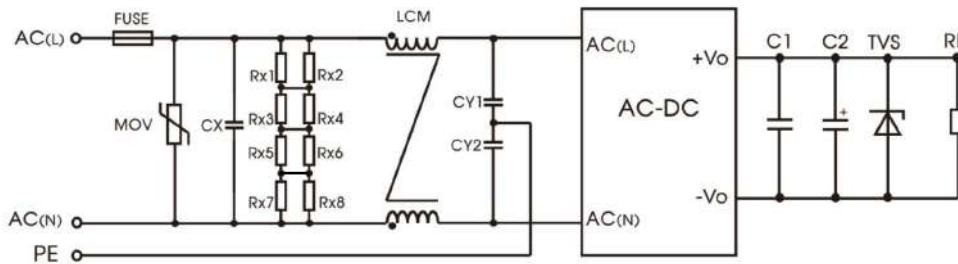



Fig. 3: Recommended circuit for class I equipment

Component	Recommended value
FUSE	3.15A/500V, slow-blow, required
MOV	S14K550
CX	0.1uF/480VAC
CY1/CY2	1nF/400VAC
LCM	10mH, P/N: FL2D-Z5-103 (MORNSUN) is recommended

Note: Rx1/Rx2/Rx3/Rx4/Rx5/Rx6/Rx7/Rx8 is the bleeder resistance of CX, and the recommended resistance value is <math><2.5M \Omega</math>.

3. For additional information please refer to application notes on www.mornsun-power.com.

Dimensions and Recommended Layout

THIRD ANGLE PROJECTION 

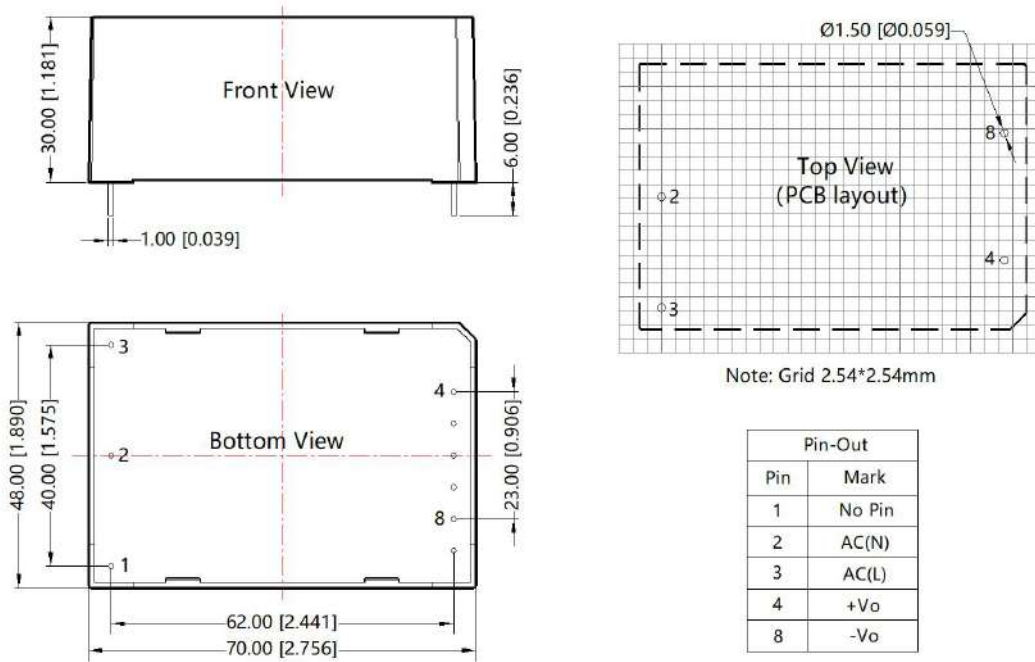

Note:
Unit: mm[inch]
Pin diameter tolerances: ± 0.10 [± 0.004]
General tolerances: ± 0.50 [± 0.020]

Pin-Out	
Pin	Mark
1	No Pin
2	AC(N)
3	AC(L)
4	+Vo
8	-Vo

Note:

1. For additional information on Product Packaging please refer to www.mornsun-power.com. Packaging bag number: 58220017;
2. If the product is not operated within the required load range, the product performance cannot be guaranteed to comply with all parameters in the datasheet;
3. Unless otherwise specified, parameters in this datasheet were measured under the conditions of $T_a=25^\circ\text{C}$, humidity<75% with nominal input voltage and rated output load;
4. All index testing methods in this datasheet are based on our company corporate standards;
5. We can provide product customization service, please contact our technicians directly for specific information;
6. Products are related to laws and regulations: see "Features" and "EMC";
7. Our products shall be classified according to ISO14001 and related environmental laws and regulations, and shall be handled by qualified units.

Mornsun Guangzhou Science & Technology Co., Ltd.

Address: No. 8 Nanyun 4th Road, Huangpu District, Guangzhou, China

Tel: 86-20-38601850

Fax: 86-20-38601272

E-mail: info@mornsun.cn

www.mornsun-power.com